



LED Display Product Data Sheet LSHD-7803

Spec No. :DS30-2002-149
Effective Date: 01/13/2023
Revision: B

LITE-ON DCC

RELEASE

**LED DISPLAY
LSHD-7803**

LED DISPLAY

LSHD-7803

<u>Rev</u>	<u>Description</u>	<u>By</u>	<u>Date</u> <u>DD/MM/YYYY</u>
01	Preliminary SPEC	Thomas Yu	01/14/2003
Above data for PD and Customer tracking only			
-	Preliminary SPEC	Thomas Yu	01/14/2003
A	add subcon GLD	Erin Cheng	09/01/2010
B	1. Add AllnGaP dice in description at page 2 2. Update of Electrical/Optical Characteristics at page 5 3. Correct typical Electrical/Optical Characteristics Curves at page 6	William Lin	12/29/2022

LED DISPLAY LSHD-7803

1. Description

The LSHD-7803 is a 0.3 inch (7.62 mm) digit height single-digit display. This device uses GREEN LED chips (GaP epi on GaP substrate/AlInGaP on a non-transparent GaAs substrate). The display has gray face and green segments.

1.1 Features

- * 0.3 inch (7.62 mm) DIGIT HEIGHT
- * EXCELLENT SEGMENT UNIFORMITY
- * LOW POWER REQUIREMENT
- * HIGH BRIGHTNESS AND HIGH CONTRAST
- * WIDE VIEWING ANGLE
- * SOLID STATE RELIABILITY
- * BINNED FOR LUMINOUS INTENSITY
- * LEAD-FREE PACKAGE (ACCORDING TO ROHS)

1.2 Device

Part No	Description
GREEN	Common Cathode
LSHD-7803	Rt. Hand Decimal

LED DISPLAY LSHD-7803

2. Package Dimensions

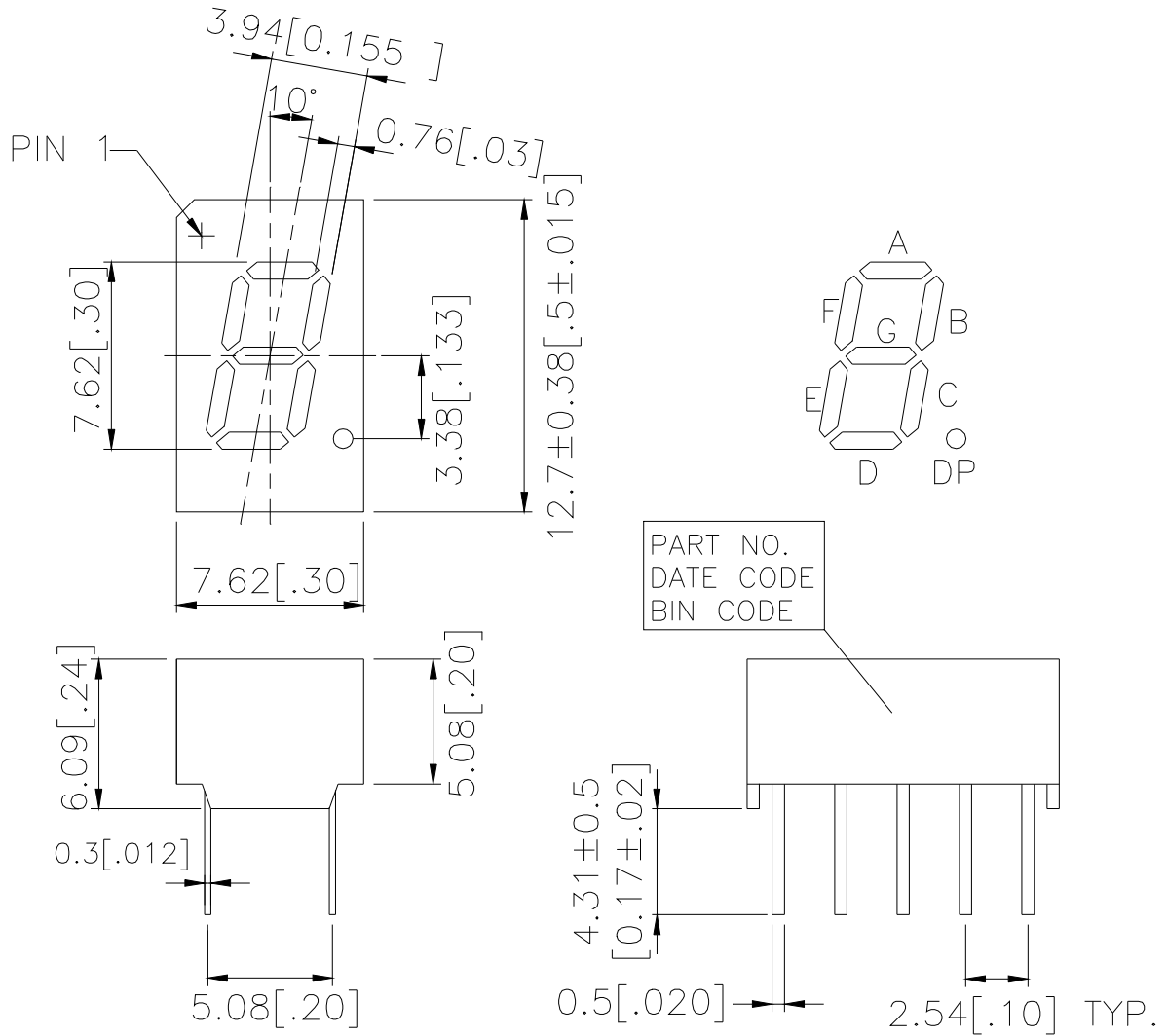

Notes :

1. All dimensions are in millimeters. Tolerances are ± 0.25 mm (0.01") unless otherwise noted
2. Pin tip's shift tolerance is ± 0.4 mm

**LED DISPLAY
LSHD-7803**

3. Internal Circuit Diagram

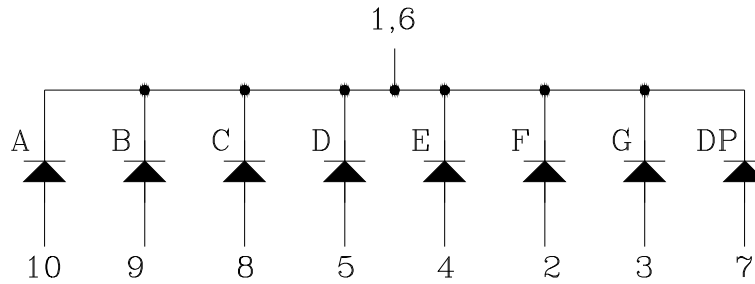

4. Pin Connection

No.	CONNECTION
1	Common Cathode
2	Anode F
3	Anode G
4	Anode E
5	Anode D
6	Common Cathode
7	Anode DP
8	Anode C
9	Anode B
10	Anode A

LED DISPLAY LSHD-7803

5. Rating and Characteristics

5.1. Absolute Maximum Rating at Ta=25°C

Parameter	Maximum Rating	Unit
Average Power Dissipation Per dot	75	mW
Peak Forward Current Per Segment (1/10 Duty Cycle, 0.1ms Pulse Width)	60	mA
Average Forward Current Per dot	25	mA
Forward Current Derating from 25°C	0.28	mA/°C
Operating Temperature Range	-35°C to +105°C	
Storage Temperature Range	-35°C to +105°C	
Soldering Conditions: 1/16 inch below seating plane for 3 seconds at 260°C		

5.2. Electrical / Optical Characteristics at Ta=25°C

Parameter	Symbol	MIN.	TYP.	MAX.	Unit	Test Condition
Average Luminous Intensity	IV	500	1600		ucd	IF=10mA
Peak Emission Wavelength	λ_p		565		nm	IF=20mA
Spectral Line Half-Width	$\Delta\lambda$		30		nm	IF=20mA
Dominant Wavelength	λ_d		569		nm	IF=20mA
Forward Voltage Per Segment	VF		2.1	2.6	V	IF=20mA
Reverse Current Per Segment	IR			100	μ A	VR=5V
Luminous Intensity Matching Ratio (Similar Light Area)	IV-m			2:1		IF=10mA

Notes:

- Luminous intensity is measured with a light sensor and filter combination that approximates the CIE (Commission International De L'Eclairage) eye-response curve
- Crosstalk specification $\leq 2.5\%$
- Reverse voltage is only for IR test, it cannot continue to operate this situation.

**LED DISPLAY
LSHD-7803**

5.3. Typical Electrical / Optical Characteristics Curves

(25°C Ambient Temperature Unless Otherwise Noted)

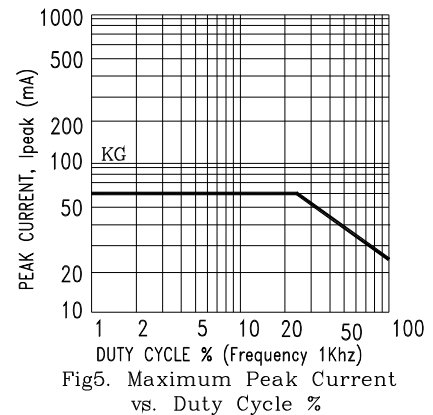
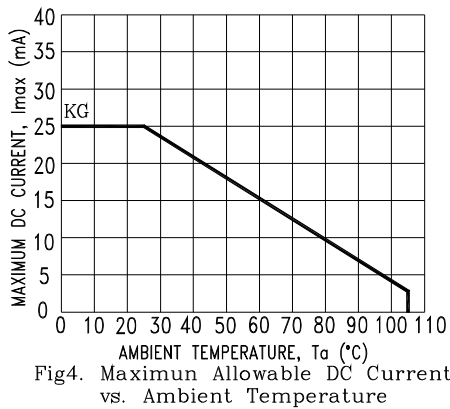
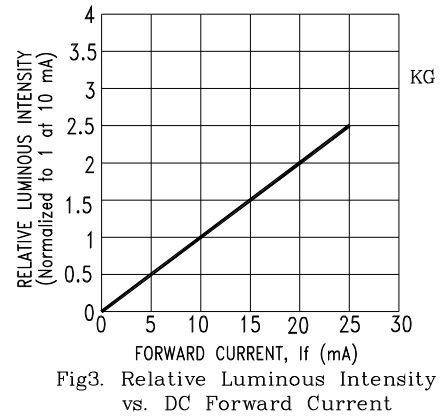
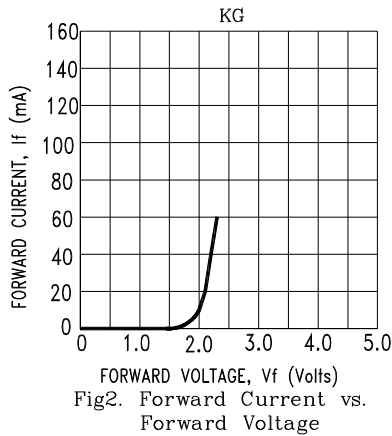
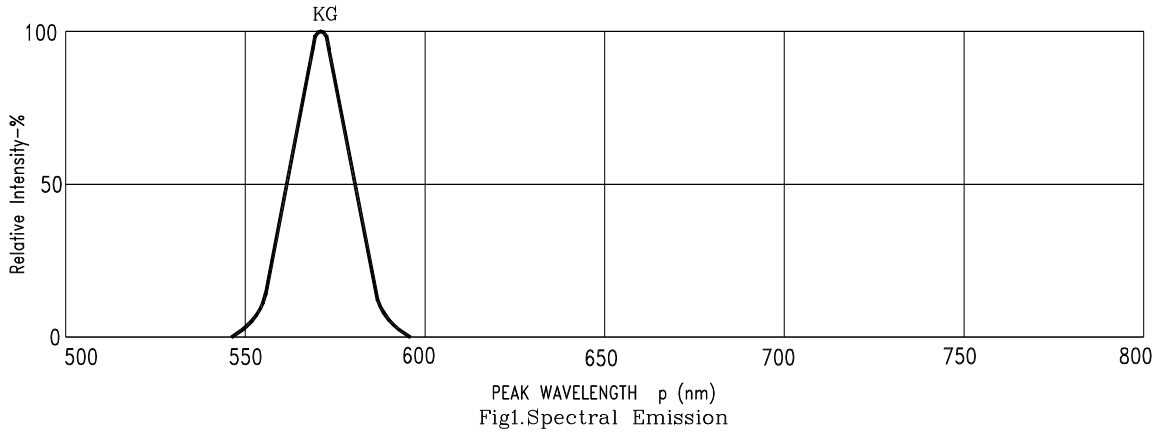

NOTE : KG=AlInGaP Green

LED DISPLAY LSHD-7803

6. CAUTIONS

6.1. Application

- The display described here are intended to be used for ordinary electronic equipment (such as office equipment, communication equipment and household applications). Consult Liteon's Sales in advance for information on applications in which exceptional reliability is required, particularly when the failure or malfunction of the display may directly jeopardize life or health (such as in aviation, transportation, traffic control equipment, medical and life support systems and safety devices).
- When using this LED display, please make sure absolute maximum ratings and the instructions for using outlined in these specification sheets. LITEON will not be responsible for any damage resulting from use of the product which does not comply with the absolute maximum ratings and the instructions included in these specification sheets.
- Excess driving current and/or operating temperature higher than recommended conditions may result in severe light degradation or premature failure.
- The driving circuit should be designed to protect the LEDs inside the display against reverse voltages and transient voltage spikes when the circuit is powered up or shut down.
- Constant current driving is recommended to ensure consistent performance.
- Circuit design must cater to the whole range of forward voltage (VF) of the LEDs inside the display to ensure the intended drive current can always be achieved.
- The safe operating current should be chosen after considering the maximum ambient temperature of the operating environment.
- Reverse bias should be avoided, as it could cause metal migration, leading to an increase in leakage current or causing a short circuit.
- Avoid rapid changes in ambient temperatures, especially in high-humidity environments, because they cause condensation on the LED/LED display.
- Do not use unsuitable tool or assembly method to have abnormal force on display body cause damage.
- Printing/pattern film is using pressure sensitive glue to stick on LED display surface, not recommend to let LED display pattern film side close contact with front panel/cover, since the printing/pattern film may shift or moved from original position by external force.
- Recommend choose same BIN LED display while you assemble 2 or above 2 pcs LED display for one set application to avoid hue uneven problems.

LED DISPLAY LSHD-7803

6.2. Storage conditions

- LED Display standard storage condition.
 - Product in the original packaging material state is recommended storage conditions.
 - Temperature Condition: 5°C~30°C
 - Humidity Condition: Below 60%RH

If the storage conditions do not meet specification standards, the LED display pins may become oxidized requiring re-plating and re-sorting before use. Suggest customers consume display as soon as possible, and avoid long-term storage of large inventories.

- LED SMD Display standard storage condition
 - When the package is in factory original sealed bag.
 - Temperature Condition: 5°C~30°C
 - Humidity Condition: Below 60%RH
 - When the package is opened and not in factory original sealed bag.
 - Temperature Condition: 5°C~30°C
 - Humidity Condition: Below 60%RH
 - Storage time: Within 168Hr (MSL as level 3)

If the storage conditions do not meet specification standards, the LED display pins or soldering pads may become oxidized requiring re-plating and re-sorting before use. Suggest customers consume display as soon as possible, and avoid long-term storage of large inventories.

- Recommend to baking the LEDs at 60 °C for 24hrs before soldering process if the LED SMD Display were unpacked more than 168hrs.

- The Displays recommend to used within 12 months from shipping date.

- The Displays should not be exposed to an environment where high level of moisture or corrosive gases are present.

- LED display pins and soldering pads are plated with gold, tin, or other metals. Under long-term exposure to open air, the exposed pins and pads may become oxidized causing poor solderability. Therefore opened but unused parts must be stored in sealed containers or controlled environment. Suggest to store unused SMD Display parts in the original moisture barrier bag and sealed.

- Moisture control for components already mounted on PCB
 - If the PCB will not undergo additional reflow soldering or high-temperature processes, then no special treatment is required for the mounted moisture-sensitive SMD components. If the PCB will undergo multiple reflow soldering or other high-temperature processes, including rework, then the SMD component's cumulative exposure time until the final high-temperature process must be controlled to within the specified time limit.

6.3. Cleaning

- Do not use unspecified chemical liquid to clean display they could harm the package.

LED DISPLAY LSHD-7803

6.4. ESD (Electrostatic Discharge)

Static Electricity or power surge will damage LED inside the display.

Suggestions to prevent ESD damage:

- Use of a conductive wrist band or anti-electrostatic glove when handling these LED displays.
- All devices, equipment, and machinery, working tables, storage racks, etc. must be properly grounded.
- Use ion blower to neutralize the static charge which might have built up on surface of the LED display plastic as a result of friction between LED display during storage and handling.

6.5. Terms and conditions for the usage of this document

- Keep same appearance and performance the contents of the product may be modified for productivity and reliability improvement without prior notice.
- The information included in this document reflects representative usage scenarios and is intended for technical reference only.
- When using the products referenced in this document, please make sure the product is being operated within the environmental and electrical limits specified in the datasheet. If customer usage exceeds the specified limits, LITEON will not be responsible for any subsequent issues.
- Excess driving current and/or operating temperature higher than recommended conditions may result in severe light degradation or premature failure.
- The information in this document applies to typical usage in consumer electronics applications. If customer's application has special reliability requirements or have life-threatening liabilities, such as automotive or medical usage, please consult with LITEON representative for further assistance.
- The contents and information of this document may not be reproduced or re-transmitted without permission by LITEON.
- When any special process such as potting is required for LED display assembly, please consult with LITEON representative before proceeding.
- Over-current-proof
Customer must apply resistors for protection, otherwise slight voltage shift will cause big current change (Burn out will happen).