



Through Hole Lamp Product Data Sheet LTW-1DEEDNJ

Spec No. :DS20-2023-0022
Effective Date: 03/19/2024
Revision: A

LITE-ON DCC

RELEASE

BNS-OD-FC001/A4

Through Hole Lamp
LTW-1DEEDNJ

Through Hole Lamp
LTW-1DEEDNJ

<u>Rev</u>	<u>Description</u>	<u>By</u>	<u>Date</u>
P001	Preliminary SPEC(RDR-20210815-01)	Norah	8/24/2021
P002	Correct drawing of outline dimensions	Norah	9/8/2021
P003	Update Wd & CIE bin table	Norah	10/4/2021
Above data for PD and Customer tracking only			
-	NPPR Received and Upload to system	Norah	2/20/2023
A	Add halogen free features	Norah	3/14/2024

Through Hole Lamp LTW-1DEEDNJ

1. Description

Through hole LEDs are offered in a variety of packages such as 3mm, 4mm, 5mm, rectangular, and cylinder which are suitable for all applications requiring status indication. Several intensity and viewing angle choices are available in each color for design flexibility.

1.1. Features

- Low power consumption & High efficiency
- Lead free & RoHS Compliant
- Halogen Free (Cl⁻<900ppm, Br⁻<700ppm, and Cl⁻+Br⁻<1500ppm)
- AlInGaP Red 625nm and White common cathode lamp with white diffused lens

1.2. Applications

- Communication
- Computer
- Consumer
- Home appliance

2. Outline Dimensions

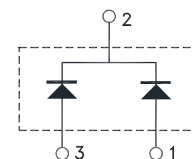
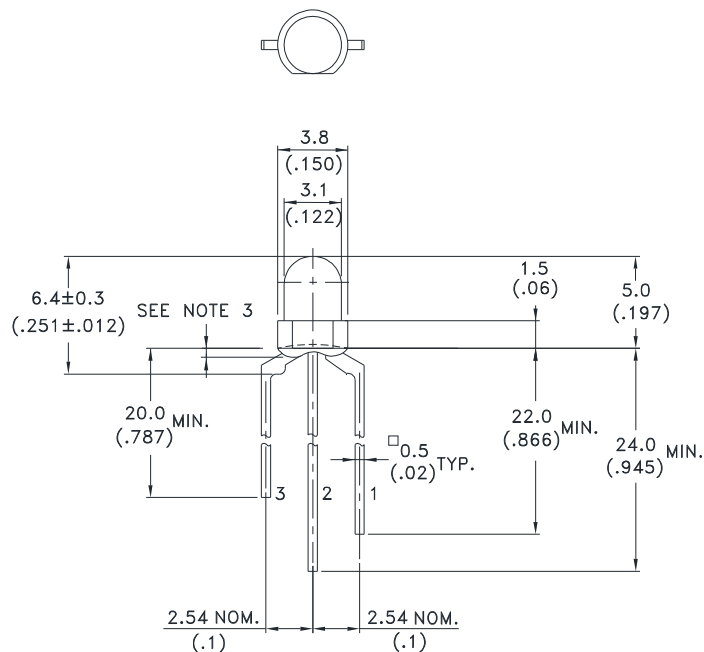

1. Red Anode
2. Common Cathode
3. White Anode

Notes :

1. All dimensions are in millimeters (inches).
2. Tolerance is ±0.25mm (.010") unless otherwise noted.
3. Protruded resin under flange is 1.0mm (.04") max.
4. Lead spacing is measured where the leads emerge from the package.
5. Specifications are subject to change without notice.

Through Hole Lamp LTW-1DEEDNJ

3. Absolute Maximum Ratings at TA=25°C

Parameter	Red	White	Unit
Power Dissipation	52	72	mW
Peak Forward Current (Duty Cycle \leq 1/10, Pulse Width \leq 10ms)	60	60	mA
DC Forward Current	20	20	mA
Operating Temperature Range	-30°C to + 85°C		
Storage Temperature Range	-40°C to + 100°C		
Lead Soldering Temperature [2.0mm (.079") From Body]	260°C for 5 Seconds Max.		

4. Electrical / Optical Characteristics at TA=25°C

Parameter	Symbol	Color	Min.	Typ.	Max.	Unit	Test Condition
Radiant Intensity	Iv	Red	110	180	310	mcd	IF = 20mA Note 1,4
		White	520	1500	2500		
Viewing Angle	$\theta_{1/2}$	Red White	-	60	-	deg	Note 2 (Fig.6)
Dominant Wavelength	λ_d	Red	618	624	630	nm	Note 3
Chromaticity Coordinates	x	White	-	0.26	-	nm	IF = 20mA, Note 5 Hue Spec. Table & Chromaticity Diagram
	y		-	0.24	-	nm	
Forward Voltage	VF	Red	1.6	2.1	2.6	V	IF = 20mA
		White	2.6	3.1	3.6		
Reverse Current	IR	Red White	-	-	10	μ A	VR = 5V

NOTE:

- Luminous intensity is measured with a light sensor and filter combination that approximates the CIE eye-response curve.
- $\theta_{1/2}$ is the off-axis angle at which the luminous intensity is half the axial luminous intensity.
- The dominant wavelength, λ_d is derived from the CIE chromaticity diagram and represents the single wavelength which defines the color of the device.
- Iv guarantee must be included with $\pm 15\%$ testing tolerance.
- Reverse voltage (VR) condition is applied for IR test only. The device is not designed for reverse operation.

Through Hole Lamp LTW-1DEEDNJ

5. Typical Electrical / Optical Characteristics Curves

(25°C Ambient Temperature Unless Otherwise Noted)

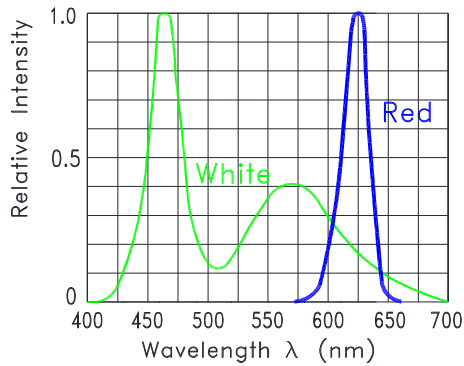

Fig.1 Relative Intensity VS. Wavelength

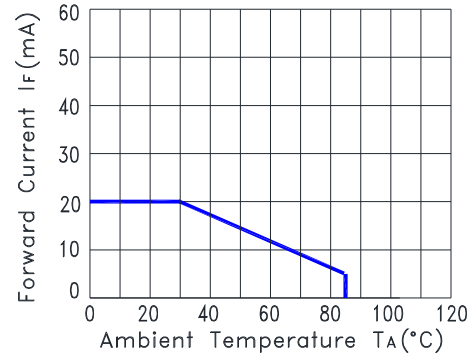

Fig.2 Forward Current Derating Curve

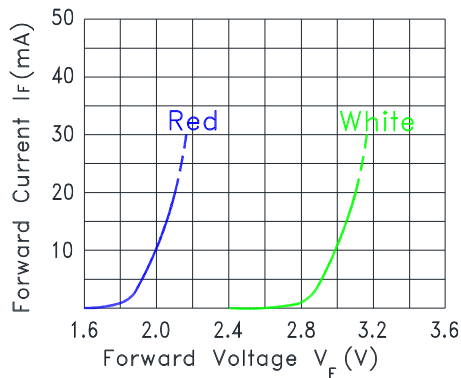

Fig.3 Forward Current vs. Forward Voltage

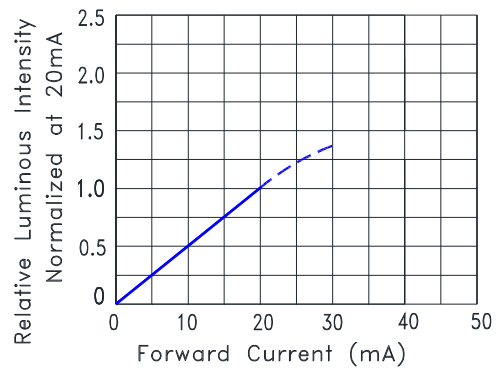

Fig.4 Relative Luminous Intensity vs. Forward Current

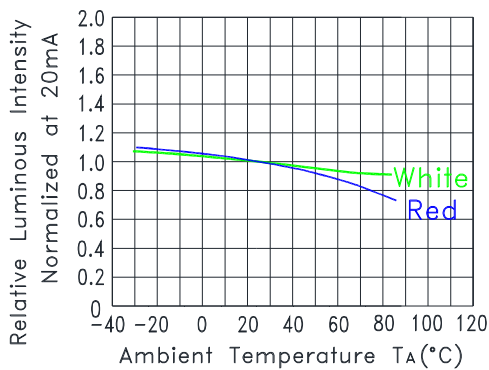

Fig.5 Relative Luminous Intensity VS. Ambient Temperature

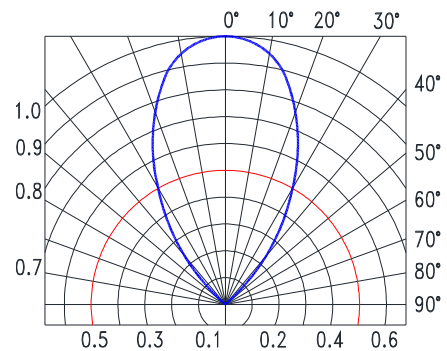
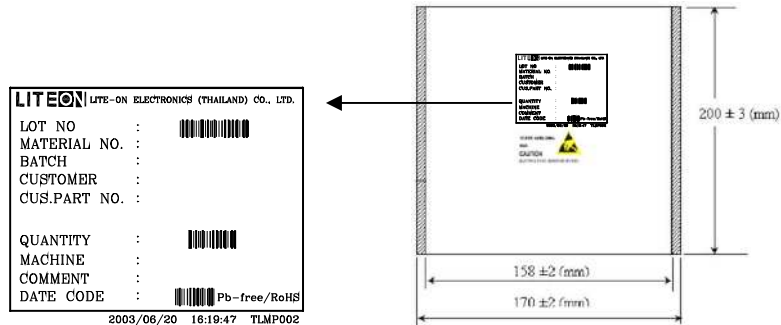

Fig.6 Spatial Distribution

Through Hole Lamp LTW-1DEEDNJ

6. Packing Spec.

500, 200 or 100 pcs per packing bag



10 packing bags per inner carton

Total 5,000 pcs per inner carton

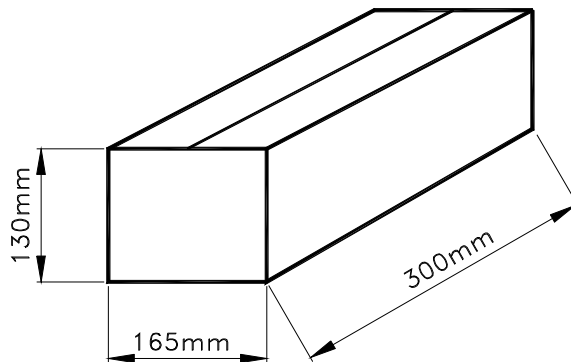

8 Inner cartons per outer carton

Total 40,000 pcs per outer carton

In every shipping lot, only the last pack will be non-full packing

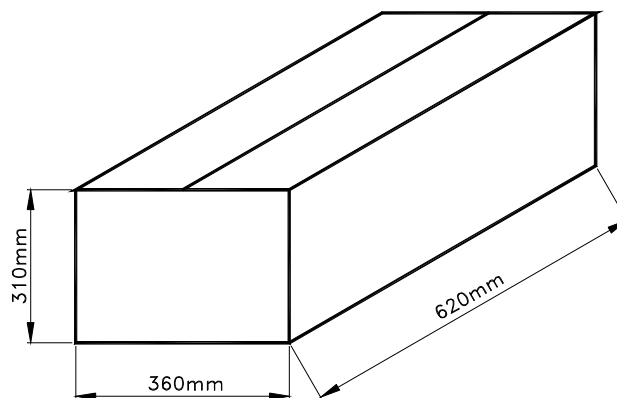

Through Hole Lamp LTW-1DEEDNJ

7. Bin Table Specification

Bin Code	Luminous Intensity (Red) Unit : mcd, IF@20mA		Bin Code	Luminous Intensity (White) Unit : mcd, IF@20mA	
	Min.	Max.		Min.	Max.
FG	110	180	MN	520	880
HJ	180	310	PQ	880	1500
-	-	-	RS	1500	2500

Note: Tolerance of each bin limit is $\pm 15\%$

Dominant Wavelength (Red) Unit : nm, IF@20mA		
Bin Code	Min	Max
R1	618	630

Note: Tolerance of each bin limit is $\pm 1\text{nm}$

Hue Ranks	Chromaticity Coordinates (White), IF@20mA				
G1	x	0.2550	0.2800	0.2800	0.2550
	y	0.2210	0.2590	0.2940	0.2555
H1	x	0.2300	0.2550	0.2550	0.2300
	y	0.1830	0.2210	0.2555	0.2180

Note: Color Coordinates Measurement allowance is ± 0.01

Through Hole Lamp
LTW-1DEEDNJ

C.I.E. 1931 Chromaticity Diagram

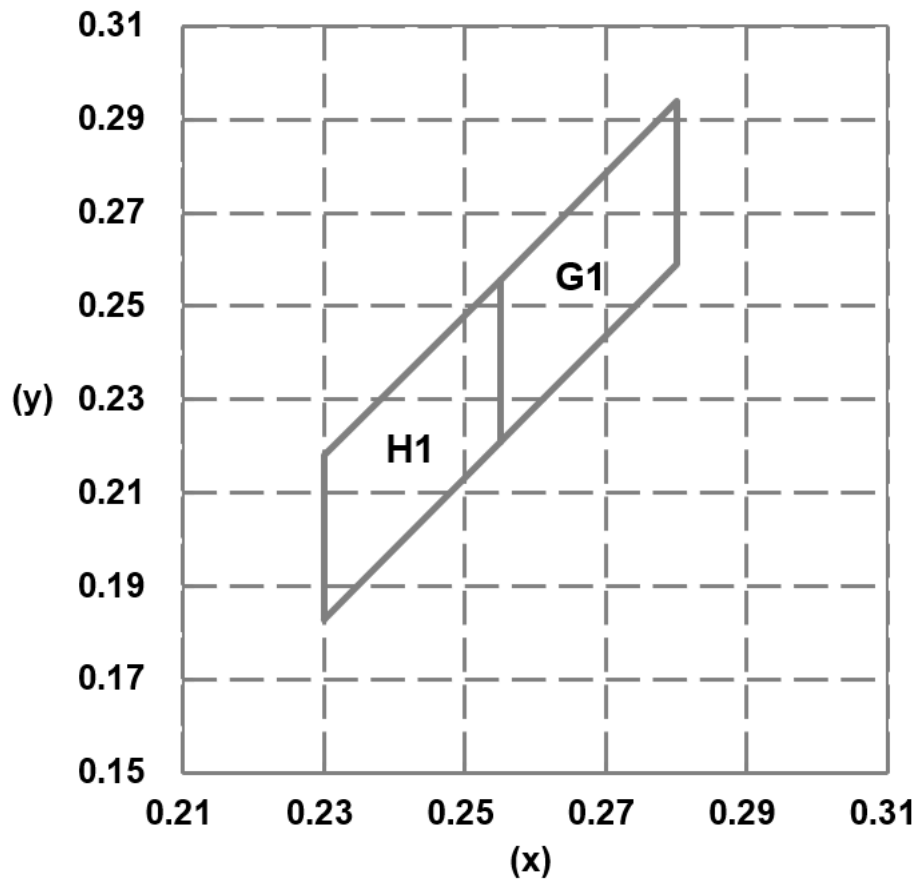

Through Hole Lamp LTW-1DEEDNJ

8. CAUTIONS

8.1. Application

This LED lamp is good for application of indoor and outdoor sign, also ordinary electronic equipment.

8.2. Storage

The storage ambient for the LEDs should not exceed 30°C temperature or 70% relative humidity. It is recommended that LEDs out of their original packaging are used within three months. For extended storage out of their original packaging, it is recommended that the LEDs be stored in a sealed container with appropriate desiccant or in desiccators with nitrogen ambient.

8.3. Cleaning

Use alcohol-based cleaning solvents such as isopropyl alcohol to clean the LEDs if necessary.

8.4. Lead Forming & Assembly

During lead forming, the leads should be bent at a point at least 3mm from the base of LED lens. Do not use the base of the lead frame as a fulcrum during forming. Lead forming must be done before soldering, at normal temperature. During assembly on PCB, use minimum clinch force possible to avoid excessive mechanical stress.

8.5. Soldering

When soldering, leave a minimum of 2mm clearance from the base of the lens to the soldering point. Dipping the lens into the solder must be avoided. Do not apply any external stress to the lead frame during soldering while the LED is at high temperature.

Recommended soldering conditions:

Soldering iron		Wave soldering	
Temperature	350°C Max.	Pre-heat	100°C Max.
Soldering time	3 seconds Max. (one time only)	Pre-heat time	60 seconds Max.
Position	No closer than 2mm from the base of the epoxy bulb	Solder wave	260°C Max.
		Soldering time	5 seconds Max.
		Dipping Position	No lower than 2mm from the base of the epoxy bulb

Note: Excessive soldering temperature and/or time might result in deformation of the LED lens or catastrophic failure of the LED. IR reflow is not suitable process for through hole type LED lamp product.

8.6. Drive Method

An LED is a current-operated device. In order to ensure intensity uniformity on multiple LEDs connected in parallel in an application, it is recommended that a current limiting resistor be incorporated in the drive circuit, in series with each LED as shown in Circuit A below.

Circuit model (A)

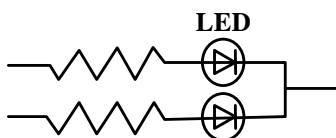

Circuit model (B)

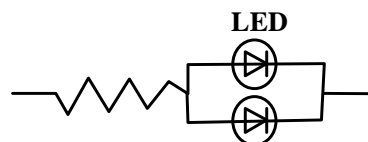

(A) Recommended circuit

(B) The brightness of each LED might appear different due to the differences in the I-V characteristics of those LEDs.

Through Hole Lamp LTW-1DEEDNJ

8.7. ESD (Electrostatic Discharge)

Static Electricity or power surge will damage the LED.

Suggestions to prevent ESD damage:

- Use a conductive wrist band or anti- electrostatic glove when handling these LEDs
- All devices, equipment, and machinery must be properly grounded
- Work tables, storage racks, etc. should be properly grounded
- Use ion blower to neutralize the static charge which might have built up on surface of the LEDs plastic lens as a result of friction between LEDs during storage and handing

Suggested checking list:

Training and Certification

- 8.7.1.1. Everyone working in a static-safe area is ESD-certified?
- 8.7.1.2. Training records kept and re-certification dates monitored?

Static-Safe Workstation & Work Areas

- 8.7.2.1. Static-safe workstation or work-areas have ESD signs?
- 8.7.2.2. All surfaces and objects at all static-safe workstation and within 1 ft measure less than 100V?
- 8.7.2.3. All ionizer activated, positioned towards the units?
- 8.7.2.4. Each work surface mats grounding is good?

Personnel Grounding

- 8.7.3.1. Every person (including visitors) handling ESD sensitive (ESDS) items wear wrist strap, heel strap or conductive shoes with conductive flooring?
- 8.7.3.1. If conductive footwear used, conductive flooring also present where operator stand or walk?
- 8.7.3.2. Garments, hairs or anything closer than 1 ft to ESD items measure less than 100V*?
- 8.7.3.3. Every wrist strap or heel strap/conductive shoes checked daily and result recorded for all DLs?
- 8.7.3.4. All wrist strap or heel strap checkers calibration up to date?

Note: *50V for Blue LED.

Device Handling

- 8.7.4.1. Every ESDS items identified by EIA-471 labels on item or packaging?
- 8.7.4.2. All ESDS items completely inside properly closed static-shielding containers when not at static-safe workstation?
- 8.7.4.3. No static charge generators (e.g. plastics) inside shielding containers with ESDS items?
- 8.7.4.4. All flexible conductive and dissipative package materials inspected before reuse or recycle?

Others

- 8.7.5.1. Audit result reported to entity ESD control coordinator?
- 8.7.5.2. Corrective action from previous audits completed?
- 8.7.5.3. Are audit records complete and on file?

Through Hole Lamp LTW-1DEEDNJ

9. Reliability Test

Classification	Test Item	Test Condition	Sample Size	Reference Standard
Endurance Test	Operation Life	Ta = Under room temperature IF = per datasheet maximum drive current Test Time= 1000hrs	22 PCS (CL=90%; LTPD=10%)	MIL-STD-750D:1026 (1995) MIL-STD-883G:1005 (2006)
	High Temperature High Humidity storage	Ta = 60°C RH = 90% Test Time= 240hrs	22 PCS (CL=90%; LTPD=10%)	MIL-STD-202G:103B (2002) JEITA ED-4701:100 103 (2001)
	High Temperature Storage	Ta= 105 ± 5°C Test Time= 1000hrs	22 PCS (CL=90%; LTPD=10%)	MIL-STD-750D:1031 (1995) MIL-STD-883G:1008 (2006) JEITA ED-4701:200 201 (2001)
	Low Temperature Storage	Ta= -55 ± 5°C Test Time= 1000hrs	22 PCS (CL=90%; LTPD=10%)	JEITA ED-4701:200 202 (2001)
Environmental Test	Temperature Cycling	100°C ~ 25°C ~ -40°C ~ 25°C 30mins 5mins 30mins 5mins 30 Cycles	22 PCS (CL=90%; LTPD=10%)	MIL-STD-750D:1051 (1995) MIL-STD-883G:1010 (2006) JEITA ED-4701:100 105 (2001) JESD22-A104C (2005)
	Thermal Shock	100 ± 5°C ~ -30°C ± 5°C 15mins 15mins 30 Cycles (<20 secs transfer)	22 PCS (CL=90%; LTPD=10%)	MIL-STD-750D:1056 (1995) MIL-STD-883G:1011 (2006) MIL-STD-202G:107G (2002) JESD22-A106B (2004)
	Solder Resistance	T.sol = 260 ± 5°C Dwell Time= 10±1 seconds 3mm from the base of the epoxy bulb	11 PCS (CL=90%; LTPD=18.9%)	MIL-STD-750D:2031(1995) JEITA ED-4701: 300 302 (2001)
	Solderability	T. sol = 245 ± 5°C Dwell Time= 5 ± 0.5 seconds (Lead Free Solder, Coverage ≥ 95% of the dipped surface)	11 PCS (CL=90%; LTPD=18.9%)	MIL-STD-750D:2026 (1995) MIL-STD-883G:2003 (2006) MIL-STD-202G:208H (2002) IPC/EIA J-STD-002 (2004)
	Soldering Iron	T. sol = 350 ± 5°C Dwell Time= 3.5 ± 0.5 seconds	11 PCS (CL=90%; LTPD=18.9%)	MIL-STD-202G:208H (2002) JEITA ED-4701:300 302 (2001)

10. Others

The appearance and specifications of the product may be modified for improvement, without prior notice.